



# PROTECTAN

The perfect finish!



## Perfect appearance without effort

For hand and foot rails in brass and chrome and for many other metal accessories, time-consuming maintenance is a thing of the past. Why? Because we are offering you a brand new series of products finished in PROTECTAN, a diamond hard and resistant titanium coating. PROTECTAN is really easy to maintain, there's no need for daily cleaning and polishing. Just wipe over with a cloth and the job's done.



## Aspect optique parfait sans grands soins

Pour les mains courantes et les rails ou plinthes en laiton et en chrome ainsi que pour tous les autres accessoires métalliques, la nécessité d'un entretien et de soins de longue durée fait maintenant partie des neiges d'antan. Nous vous offrons une toute nouvelle série de produits: PROTECTAN - un revêtement au titane, dur comme le diamant et à résistance élevée. Le revêtement PROTECTAN ne nécessite absolument aucun soin, si bien que vous pouvez vous épargner les travaux quotidiens de nettoyage et de polissage d'antan. Passer un chiffon humide suffit - tout est en ordre.



## Perfekte Optik ohne Pflegeaufwand

Für Hand- und Fußläufe in Messing und Chrom sowie für viele andere Metallaccessoires ist zeitaufwendige Pflege Schnee von gestern. Denn wir bieten Ihnen eine brandneue Produktserie: PROTECTAN - eine diamantharte und widerstandsfähige Titanbeschichtung. PROTECTAN ist absolut pflegeleicht, tägliche Reinigungs- und Polierarbeiten können Sie sich sparen. Kurz feucht abwischen - fertig.



## Perfekte look met minimaal onderhoud

Voor hand- en voetrailing in messing en chroom en voor vele andere metaal accessoires behoort tijdrovend onderhoud tot het verleden. Want wij bieden u een fonkelnieuwe productserie: PROTECTAN - een sterke titaancoating die zo hard is als diamant. PROTECTAN is absoluut onderhoudsarm. Elke dag reinigen en poetsen hoeft niet meer. Even met een vochtige doek afvegen - klaar.



**Floor and handrail brackets**  
Fuß- und Handlaufstützen  
Supports repose-pieds et main-courante  
Voet- en armsteunen

... 4



**Deco rail - System**

... 13



**Flush angles**  
Rohrverbinder  
Raccords  
Buisverbinders

... 6



**Mini rail - System**

... 16



**Posts**  
Rohrhalter  
Supports  
Opschuifsteunen

... 9



**Glass adapters and glass clamps**  
Glasadapter und Glasklemmen  
Adaptateurs et pinces à verre  
Glasadapters en glasklemmen

... 18



**End balls and caps**  
Endkugeln und -kappen  
Boutons d'ornement et embouts  
Eindbollen en -kappen

... 10



**Rods and tubes**  
Stäbe und Rohre  
Barres et tubes  
Staf en buis

... 20



**Flanges**  
Flansche  
Embases  
Flenzen

... 12



**Crowd control and accessories**  
Absperrungen und Zubehör  
Potelets et accessoires  
Afzetpalen en toebehoren

... 22

## *Finishes / Oberflächen / Finitions / Afwerkingen*



**stainless steel effect**  
Edelstahleffekt  
aspect inox brossé  
RVS look

Art.Nr. ....20



**brass effect polished**  
Messingeffekt poliert  
aspect laiton poli  
Messing look gepolijst

Art.Nr. ....22





**chrome effect polished**  
Chromeffekt poliert  
aspect chromé brillant  
Chroom look gepolijst

Art.Nr. ....23

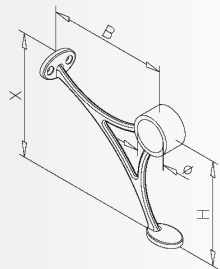

Combination bracket  
Fußlaufstütze  
Support repose-pied  
Combinatie steun





	Art.Nr.	Ø	H	B	X
	11.0101.038.22	38,1	135	155	160
	11.0101.050.22	50,8	150	150	175
	11.0101.038.23	38,1	135	155	160
	11.0101.050.23	50,8	150	150	175

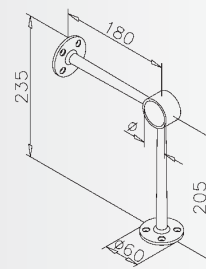

Floor bracket  
Fußlaufstütze  
Support repose-pied  
Voetsteun



	Art.Nr.	Ø
	11.0104.038.22	38,1
	11.0104.050.22	50,8
	11.0104.038.23	38,1
	11.0104.050.23	50,8



Adjustable floor bracket  
Fußlaufstütze variabel  
Support repose-pied variable  
Variabele voetsteun

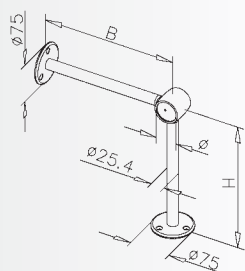

variable

	Art.Nr.	Ø	H*	B*
	11.0106.038.22	38,1	250	250
	11.0106.050.22	50,8	250	250

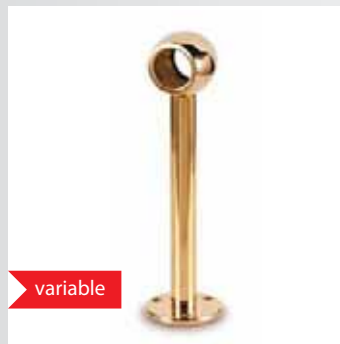

\* for other H and B measurements price on inquiry  
für andere H- und B-Maße Preis auf Anfrage  
pour autres H et B dimensions prix sur demande  
voor andere H en B maten prijs op aanvraag

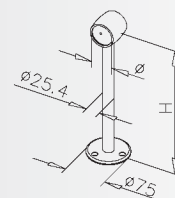

Adjustable floor bracket  
Fußlaufstütze variabel  
Support repose-pied variable  
Variabele voetsteun



variable

	Art.Nr.	Ø	H*
	11.0108.038.22	38,1	250
	11.0108.050.22	50,8	250
	11.0108.038.23	38,1	250
	11.0108.050.23	50,8	250

\* for other H measurements price on inquiry  
für andere H-Maße Preis auf Anfrage  
pour autres H dimensions prix sur demande  
voor andere H maten prijs op aanvraag

## Finishes / Oberflächen / Finitions / Afwerkingen



brass effect polished  
Messingeffekt poliert  
aspect laiton poli  
Messing look gepolijst

Art.Nr. .... 22



chrome effect polished  
Chromeffekt poliert  
aspect chromé brillant  
Chroom look gepolijst

Art.Nr. .... 23



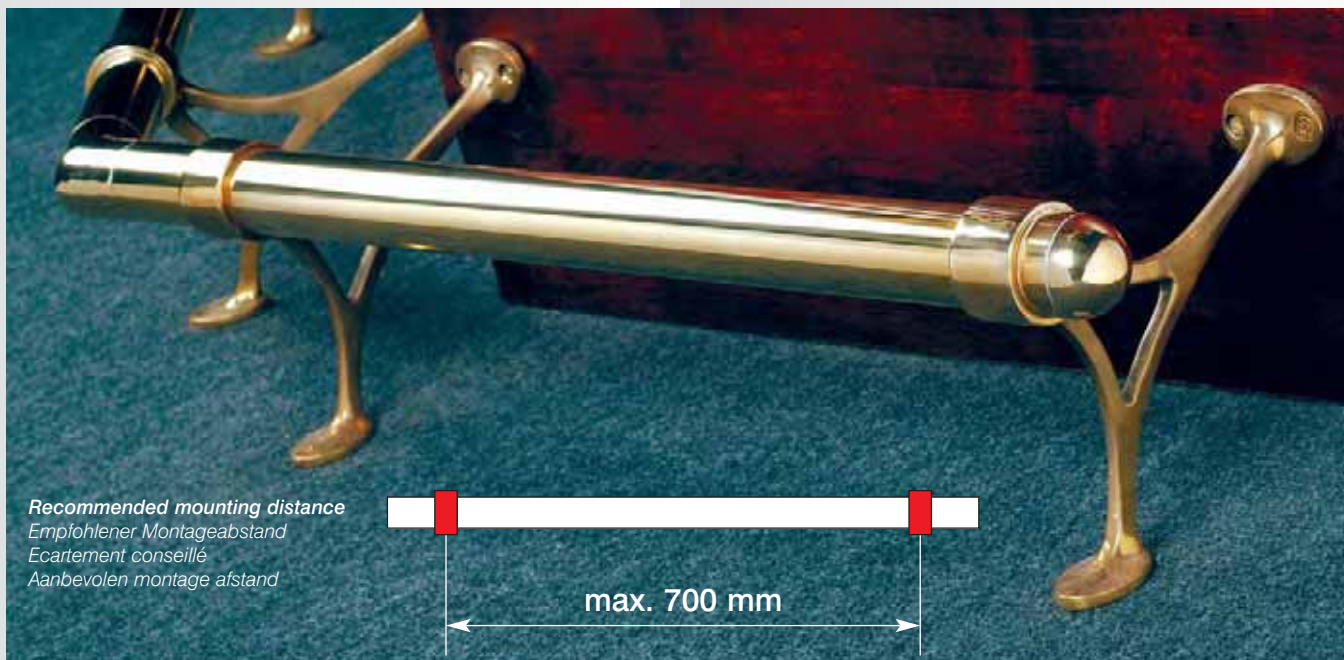

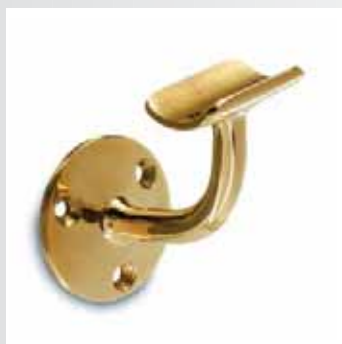

Recommended mounting distance  
 Empfohlener Montageabstand  
 Ecartement conseillé  
 Aanbevolen montage afstand

max. 700 mm

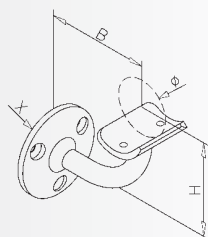

**Handrail bracket**  
 Handlaufstütze  
 Support main-courante  
 Haakse steun





	Art.Nr.	Ø	H	B	X
	11.0111.038.22	38,1	66	72	58
	11.0111.050.22	50,8	80	65	60
	11.0111.038.23	38,1	66	72	58
	11.0111.050.23	50,8	80	65	60

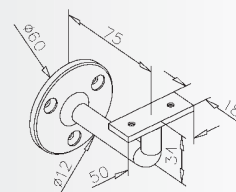

**Flat handrail bracket**  
 Handlaufstütze flach  
 Support main-courante plat  
 Vlakke leuninghouder





	Art.Nr.
	11.0119.000.22
	11.0119.000.23

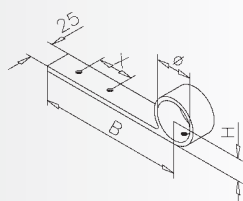

**Handrail bracket**  
 Handlaufstütze  
 Support main-courante  
 Armsteun





	Art.Nr.	Ø	H	B	X
	11.0105.025.22	25,4	16	145	40
	11.0105.038.22	38,1	23	150	37
	11.0105.050.22	50,8	30	150	40
	11.0105.025.23	25,4	16	145	40
	11.0105.038.23	38,1	23	150	37
	11.0105.050.23	50,8	30	150	40

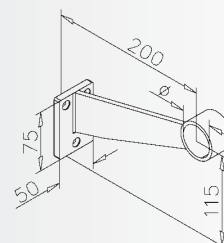

**Combination bracket**  
 Kombinationsstütze  
 Support repose-pied  
 Combinatie steun





	Art.Nr.	Ø
	11.0109.038.22	38,1
	11.0109.050.22	50,8
	11.0109.038.23	38,1
	11.0109.050.23	50,8

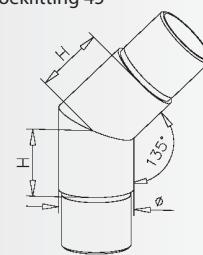

Flush angle 45°  
Rohrverbinder 45°  
Raccord 45°  
Hoekfitting 45°







	Art.Nr.	Ø	H
	11.0300.025.22	25,4	25
	11.0300.038.22	38,1	35
	11.0300.050.22	50,8	35
	11.0300.025.23	25,4	25
	11.0300.038.23	38,1	35
	11.0300.050.23	50,8	35

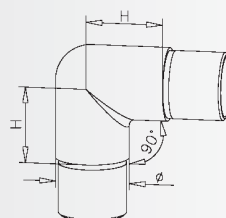

Flush elbow 90°  
Rohrverbinder 90°  
Raccord 90°  
Kniefitting 90°





	Art.Nr.	Ø	H
	11.0301.038.22	38,1	50
	11.0301.050.22	50,8	75
	11.0301.038.23	38,1	50
	11.0301.050.23	50,8	75

	Art.Nr.	Ø	H
	11.0303.025.22	25,4	25
	11.0303.038.22	38,1	40
	11.0303.050.22	50,8	40
	11.0303.025.23	25,4	25
	11.0303.038.23	38,1	40
	11.0303.050.23	50,8	40

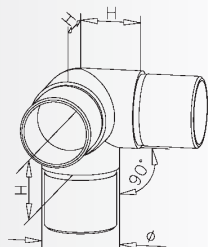

Flush elbow 90° + 1 outlet 90°  
Rohrverbinder 90° + 1 Abzw. 90°  
Raccord coude 90° + 1 départ 90°  
Kniefitting 90° + 1 uitg. 90°



	Art.Nr.	Ø	H
	11.0304.025.22	25,4	22
	11.0304.038.22	38,1	30
	11.0304.050.22	50,8	30
	11.0304.025.23	25,4	22
	11.0304.038.23	38,1	30
	11.0304.050.23	50,8	30



EXTRA-LOCK  
50 ml

High strength fixitive  
Spezialkleber  
Colle spéciale  
Lijm speciaal

Art.Nr. 19.1330.000.00

How to fix  
Einfache Verklebung  
Fixation - collage facile  
Eenvoudig te verlijmen





**Flush tee**  
Rohrverbinder T  
Raccord en T  
T-fitting

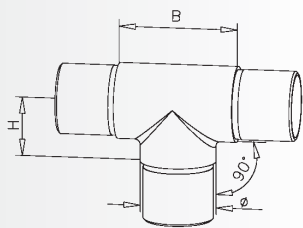

	Art.Nr.	Ø	H	B
	11.0307.025.22	25,4	22	44
	11.0307.038.22	38,1	30	60
	11.0307.025.23	25,4	22	44
	11.0307.038.23	38,1	30	60



**Flush tee + 1 outlet 90°**  
Rohrverbinder T + 1 Abzw. 90°  
Raccord en T + 1 départ 90°  
T-fitting + 1 uitg. 90°

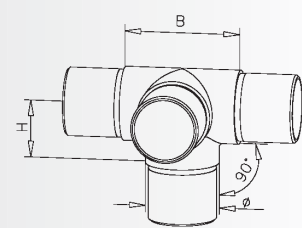

	Art.Nr.	Ø	H	B
	11.0308.025.22	25,4	25	50
	11.0308.038.22	38,1	30	60
	11.0308.025.23	25,4	25	50
	11.0308.038.23	38,1	30	60



**Connector**  
Rohrverbinder  
Raccord de liaison  
Verbindingsstuk

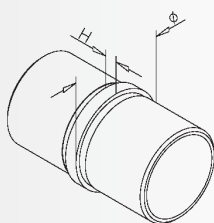

	Art.Nr.	Ø	H
	11.0790.025.22	25,4	4
	11.0790.038.22	38,1	5
	11.0790.050.22	50,8	5
	11.0790.025.23	25,4	4
	11.0790.038.23	38,1	5
	11.0790.050.23	50,8	5



**Universal fitting**  
Rohradapter  
Adaptateur tubes  
Adapter voor buis

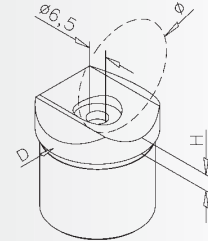

	Art.Nr.	Ø	H	D
	11.0726.050.22	50,8	8	Ø50,8
	11.0727.038.22	38,1	6	Ø38,1
	11.0727.050.22	50,8	5	Ø38,1
	11.0728.025.22	25,4	3,5	Ø25,4
	11.0728.038.22	38,1	3,5	Ø25,4
	11.0728.050.22	50,8	3,5	Ø25,4
	11.0727.038.23	38,1	6	Ø38,1
	11.0727.050.23	50,8	5	Ø38,1
	11.0728.025.23	25,4	3,5	Ø25,4
	11.0728.038.23	38,1	3,5	Ø25,4
	11.0728.050.23	50,8	3,5	Ø25,4

**Finishes / Oberflächen / Finitions / Afwerkingen**



**brass effect polished**  
Messingeffekt poliert  
aspect laiton poli  
Messing look gepolijst

Art.Nr. ....22



**chrome effect polished**  
Chromeffekt poliert  
aspect chromé brillant  
Chroom look gepolijst

Art.Nr. ....23

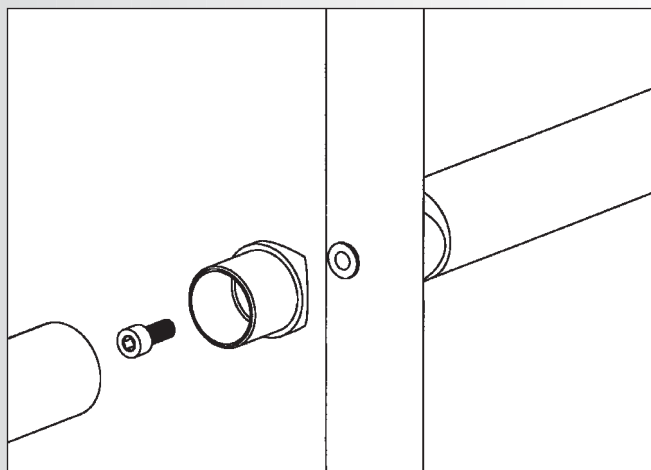





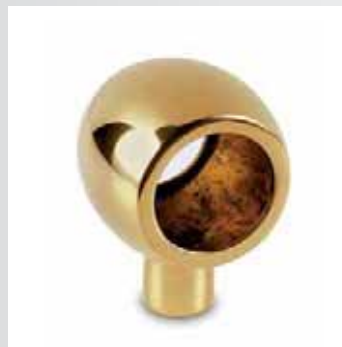
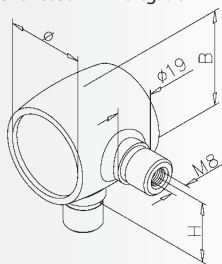

Socket elbow + 2 outlets 90°  
Kugelrohrverbinder + 2 Abzw. 90°  
Raccord support variable + 2 dép. 90°  
Opschuifsteun + 2 uitg. 90°

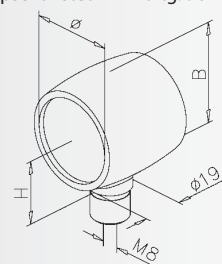

Socket elbow + 1 outlet 90°  
Kugelrohrverbinder + 1 Abzw. 90°  
Raccord support variable + 1 dép. 90°  
Opschuifsteun + 1 uitg. 90°



Art.Nr.	Ø	H	B
			

Art.Nr.	Ø	H	B	
	11.0217.038.22	38,1	30	Ø48
	11.0217.050.22	50,8	35	Ø63
	11.0217.038.23	38,1	30	Ø48
	11.0217.050.23	50,8	35	Ø63



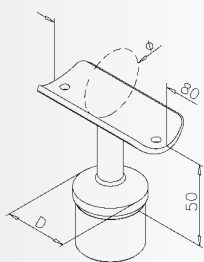

Straight saddle 90°  
Rohrstütze 90°  
Support tube  
Buissteun 90°

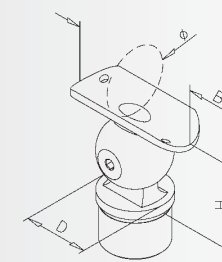

Adjustable ball saddle 20° - 90°  
Kugelrohrstütze variabel 20° - 90°  
Support orientable 20° - 90°  
Verstelbare buissteun 20° - 90°



Art.Nr.	Ø	D	
	11.0710.038.22	38,1	Ø38,1
	11.0710.050.22	50,8	Ø50,8

Art.Nr.	Ø	D	H	B	
	11.0714.038.22	38,1	Ø38,1	50	75
	11.0714.050.22	50,8	Ø50,8	65	100



**Ball centre post**  
Rohrhalter  
Support traversant  
Opschuijsteun

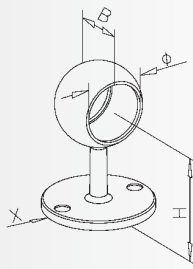

	Art.Nr.	Ø	H	B	X
	11.0600.038.22	38,1	70	34	Ø70
	11.0600.050.22	50,8	75	38	Ø82
	11.0600.038.23	38,1	70	34	Ø70
	11.0600.050.23	50,8	75	38	Ø82



**Ball end post**  
Rohrendhalter  
Support borgne  
Opschuij eindsteun

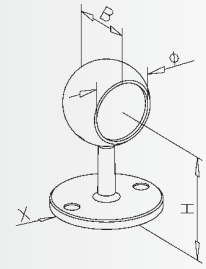

	Art.Nr.	Ø	H	B	X
	11.0601.038.22	38,1	70	44	Ø70
	11.0601.050.22	50,8	75	52	Ø82
	11.0601.038.23	38,1	70	44	Ø70
	11.0601.050.23	50,8	75	52	Ø82



**Flat centre post**  
Rohrhalter  
Support traversant  
Opschuijsteun

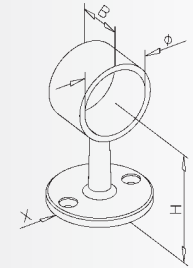

	Art.Nr.	Ø	H	B	X
	11.0602.025.22	25,4	55	18	Ø45
	11.0602.038.22	38,1	65	28	Ø56
	11.0602.050.22	50,8	84	34	Ø64
	11.0602.025.23	25,4	55	18	Ø45
	11.0602.038.23	38,1	65	28	Ø56
	11.0602.050.23	50,8	84	34	Ø64



**Flat end post**  
Rohrendhalter  
Support borgne  
Opschuij eindsteun

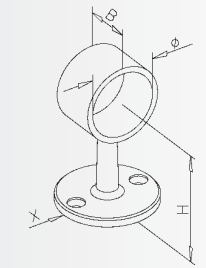

	Art.Nr.	Ø	H	B	X
	11.0603.025.22	25,4	55	18	Ø45
	11.0603.038.22	38,1	65	28	Ø56
	11.0603.050.22	50,8	84	34	Ø64
	11.0603.025.23	25,4	55	18	Ø45
	11.0603.038.23	38,1	65	28	Ø56
	11.0603.050.23	50,8	84	34	Ø64





Universal angle ball  
Endkugel  
Bouton d'ornement  
Eindbol

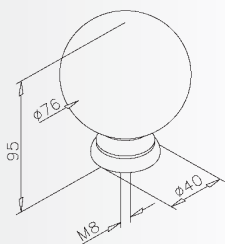

Art.Nr.
11.0211.050.22
11.0211.050.23



Ball top  
Endkugel  
Bouton d'ornement  
Eindbol

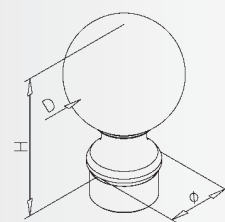

Art.Nr.	Ø	H	D
11.0212.025.22	25,4	68	Ø45
11.0212.038.22	38,1	85	Ø62
11.0212.050.22	50,8	112	Ø78
11.0212.025.23	25,4	68	Ø45
11.0212.038.23	38,1	85	Ø62
11.0212.050.23	50,8	112	Ø78



End ball  
Zierkugel  
Bouton d'ornement  
Sierkugel

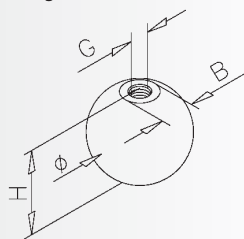

Art.Nr.	Ø	H	B	G
11.0220.020.22	20	18,5	10,5	M6
11.0220.040.22	40	38,5	15	M8
11.0220.050.22	50	48,5	17	M8
11.0220.020.23	20	18,5	10,5	M6
11.0220.040.23	40	38,5	15	M8
11.0220.050.23	50	48,5	17	M8



Finial with M8  
Zier-Abschlusscheibe  
Embout de finition fileté  
Sier afsluitkap

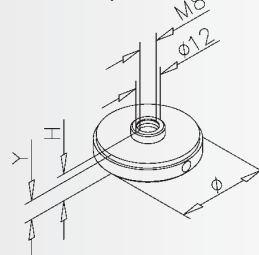

Art.Nr.	Ø	H	Y
11.0731.025.22	25,4	10,5	6
11.0731.038.22	38,1	11,5	8
11.0731.050.22	50,8	13,5	10
11.0731.025.23	25,4	10,5	6
11.0731.038.23	38,1	11,5	8



Base cover  
Abdeckkappe  
Cache embase  
Afdekkap

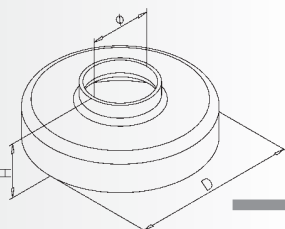

Art.Nr.	Ø	H	B
11.0511.025.22	25,4	30	Ø82
11.0511.038.22	38,1	34	Ø102
11.0511.050.22	50,8	40	Ø125
11.0511.025.23	25,4	30	Ø82
11.0511.038.23	38,1	34	Ø102
11.0511.050.23	50,8	40	Ø125



for steel tube 10.0912... / 10.0913...  
(see catalogue „Design in brass and stainless steel“, page 37)

für Stahlinnenrohr 10.0912... / 10.0913...  
(siehe Katalog „Creativ Messing und Edelstahl Design“, Seite 37)

pour tube acier 10.0912... / 10.0913...  
(voir catalogue „Design en Laiton et en Inox“, page 37)

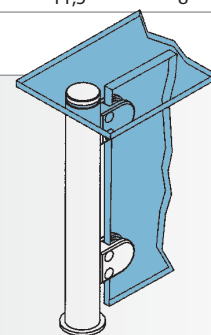

t.b.v. stalen binnen buis 10.0912... / 10.0913...  
(zie catalogus „Creatief messing en RVS design, pagina 37)



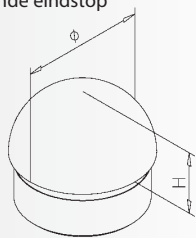

Domed end cap  
Endkappe halbrund  
Embout arrondi  
Halfronde eindstop





	Art.Nr.	Ø	H
	11.0730.025.22	25,4	13
	11.0730.038.22	38,1	19
	11.0730.050.22	50,8	25
	11.0730.025.23	25,4	13
	11.0730.038.23	38,1	19
	11.0730.050.23	50,8	25



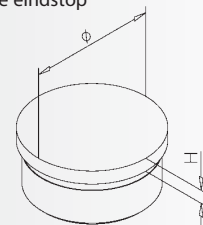

Flat end cap  
Endkappe flach  
Embout plat  
Vlakke eindstop



	Art.Nr.	Ø	H
	11.0732.025.22	25,4	3
	11.0732.038.22	38,1	4
	11.0732.050.22	50,8	4
	11.0732.025.23	25,4	3
	11.0732.038.23	38,1	4
	11.0732.050.23	50,8	4





	Art.Nr.
	11.0739.038.22
	11.0739.038.23

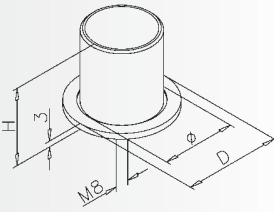

**Tube connector**  
Rohrbefestigungshülse  
Embase manchon  
Buis bevestigingsflens





	Art.Nr.	Ø	H	D
	11.0500.025.22	25,4	40	Ø40
	11.0500.038.22	38,1	40	Ø50
	11.0500.050.22	50,8	50	Ø60
	11.0500.025.23	25,4	40	Ø40
	11.0500.038.23	38,1	40	Ø50
	11.0500.050.23	50,8	50	Ø60

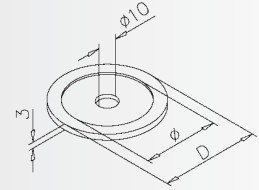

**Rosette**  
Rosette  
Rosace  
Rozet





	Art.Nr.	Ø	D
	11.0501.025.22	25,4	Ø40
	11.0501.038.22	38,1	Ø50
	11.0501.050.22	50,8	Ø60
	11.0501.025.23	25,4	Ø40
	11.0501.038.23	38,1	Ø50
	11.0501.050.23	50,8	Ø60

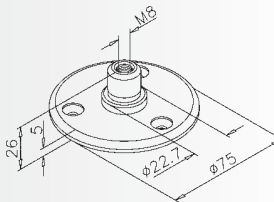

**Base flange**  
Innenflansch  
Embase manchon  
Combinatie flens





	Art.Nr.	Ø
	11.0503.025.22	25,4
	11.0503.025.23	25,4

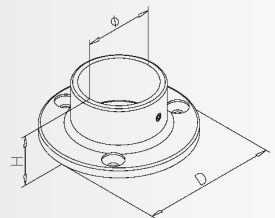

**Wall and floor flange**  
Wand- und Bodenflansch  
Embase  
Muur en vloer flens





	Art.Nr.	Ø	H	B
	11.0505.025.22	25,4	22	Ø52
	11.0505.038.22	38,1	28	Ø75
	11.0505.050.22	50,8	30	Ø100
	11.0505.025.23	25,4	22	Ø52
	11.0505.038.23	38,1	28	Ø75
	11.0505.050.23	50,8	30	Ø100

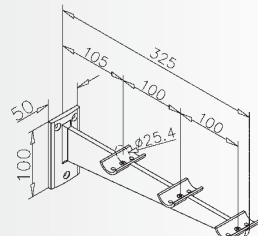

**Tray slide bracket**  
Tablettruscenträger  
Support porte-plateaux  
Buizensteun



	Art.Nr.
	11.0123.025.22
	11.0123.025.23



**Tube lamp connector**  
Halogenstrahler (Rohraufsatz)  
Spot halogène  
Halogeenspot (opbouw)

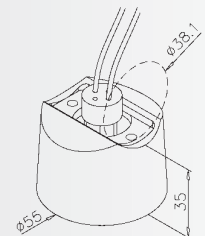

	Art.Nr.
	11.0990.038.22

incl. illuminant 20 W  
inkl. Leuchtmittel 20 W  
comprenant ampoule 20 W  
incl. halogeenspot 20 W

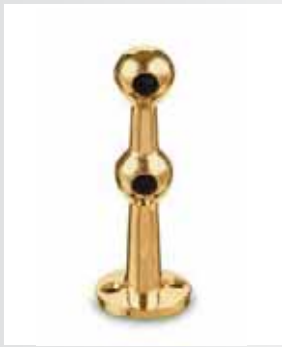

Double mini-fiddle rail end bracket  
Doppelte Endstütze  
Double support borgne  
Dubbele eindsteun

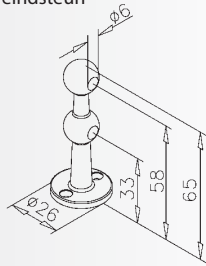

Art.Nr.

11.0610.006.22



11.0610.006.23

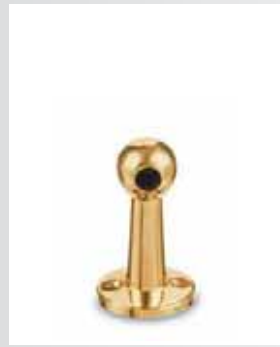

Mini-fiddle rail end bracket  
Endstütze  
Support borgne  
Eindsteun

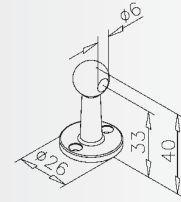

Art.Nr.

11.0613.006.22



11.0613.006.23

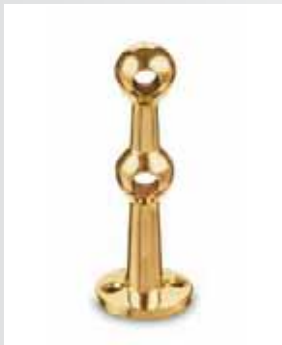

Double mini-fiddle rail centre bracket  
Doppelte offene Stütze  
Double support traversant  
Dubbele opschuifsteun

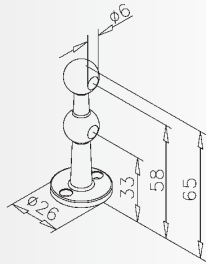

Art.Nr.

11.0611.006.22



11.0611.006.23



Mini-fiddle rail centre bracket  
Offene Stütze  
Support traversant  
Opschuifsteun

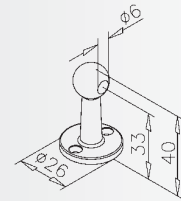

Art.Nr.

11.0614.006.22



11.0614.006.23



Double mini-fiddle rail elbow bracket 90°  
Doppelte Eckstütze 90°  
Double raccord d'angle 90°  
Dubbele hoeksteun 90°

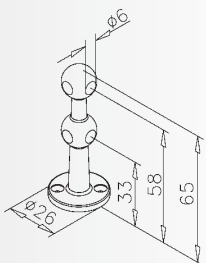

Art.Nr.

11.0612.006.22



11.0612.006.23



Mini-fiddle rail elbow bracket 90°  
Eckstütze 90°  
Raccord d'angle 90°  
Hoeksteun 90°

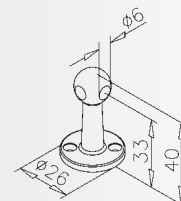

Art.Nr.

11.0615.006.22



11.0615.006.23



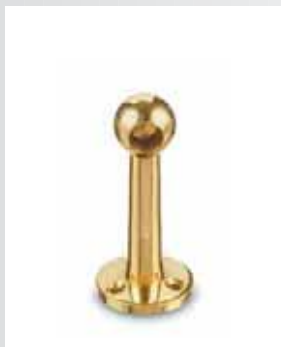

**Fiddle rail end bracket**

Endstütze  
Support borgne  
Eindsteun

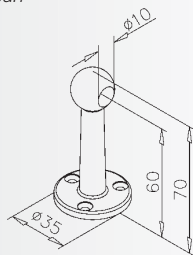

Art.Nr.

11.0630.010.22



11.0630.010.23

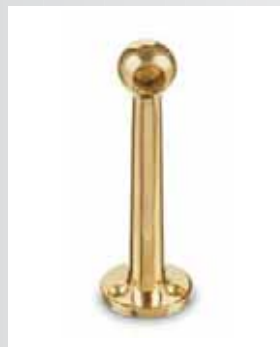

**Fiddle rail end bracket**

Endstütze  
Support borgne  
Eindsteun

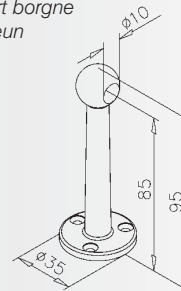

Art.Nr.

11.0640.010.22



11.0640.010.23

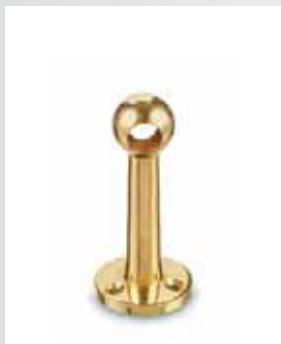

**Fiddle rail centre bracket**

Offene Stütze  
Support traversant  
Opschuifsteun

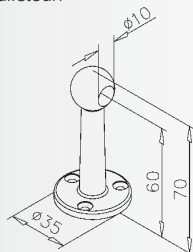

Art.Nr.

11.0631.010.22



11.0631.010.23



**Fiddle rail centre bracket**

Offene Stütze  
Support traversant  
Opschuifsteun

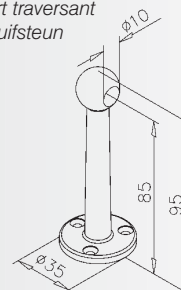

Art.Nr.

11.0641.010.22



11.0641.010.23



**Fiddle rail elbow bracket 90°**

Eckstütze 90°  
Raccord d'angle 90°  
Hoeksteun 90°

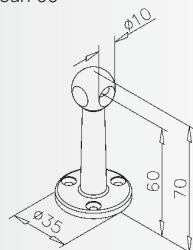

Art.Nr.

11.0632.010.22



11.0632.010.23



**Fiddle rail elbow bracket 90°**

Eckstütze 90°  
Raccord d'angle 90°  
Hoeksteun 90°

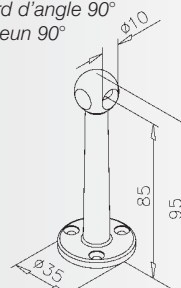

Art.Nr.

11.0642.010.22



11.0642.010.23





Double fiddle rail end bracket  
Doppelte Endstütze  
Double support borgne  
Dubbele eindsteun

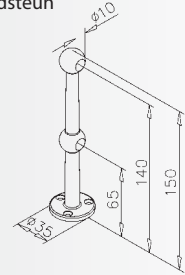

Art.Nr.

11.0650.010.22



11.0650.010.23



Double fiddle rail centre bracket  
Doppelte offene Stütze  
Double support traversant  
Dubbele opschuifsteun

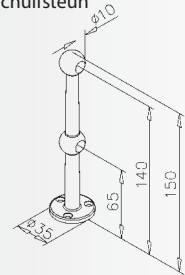

Art.Nr.

11.0651.010.22



11.0651.010.23



Double fiddle rail elbow bracket 90°  
Doppelte Eckstütze 90°  
Double raccord d'angle 90°  
Dubbele hoeksteun 90°

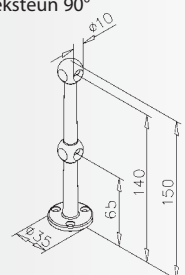

Art.Nr.

11.0652.010.22



11.0652.010.23



Finishes / Oberflächen / Finitions / Afwerkingen

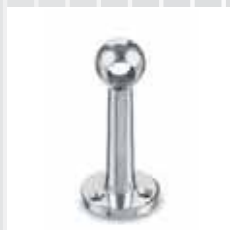





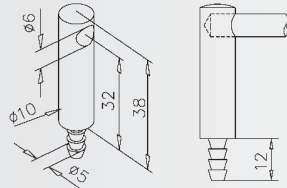

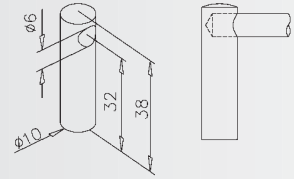

**„Mini rail“**  
**End bracket for mounting on wood**  
 Endstütze für Holzmontage  
 Support borgne, fixation sur bois  
 Eindsteun voor montage op hout



**„Mini rail“**  
**End bracket for glue fixation**  
 Endstütze für Klebemontage  
 Support borgne, fixation avec colle  
 Eindsteun voor lijm montage



Art.Nr.
 11.0660.006.20
 11.0660.006.22
 11.0660.006.23

Art.Nr.
 11.0670.006.20
 11.0670.006.22
 11.0670.006.23



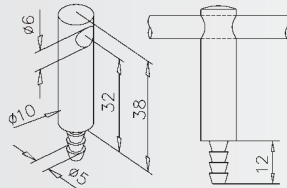

**„Mini rail“**  
**Centre bracket for mounting on wood**  
 Mittelstütze für Holzmontage  
 Support traversant, fixation sur bois  
 Middensteun voor montage op hout

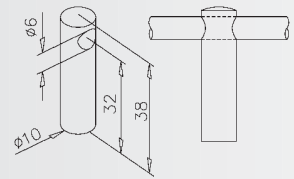

**„Mini rail“**  
**Centre bracket for glue fixation**  
 Mittelstütze für Klebemontage  
 Support traversant, fixation avec colle  
 Middensteun voor lijm montage



Art.Nr.
 11.0661.006.20
 11.0661.006.22
 11.0661.006.23

Art.Nr.
 11.0671.006.20
 11.0671.006.22
 11.0671.006.23

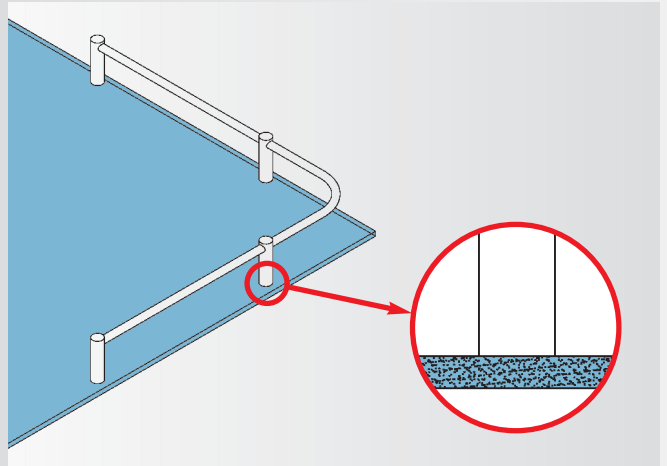
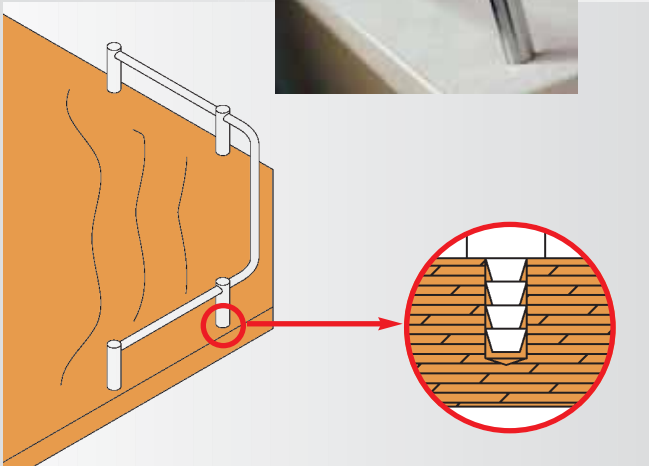



**„Mini rail“**  
**End bracket for mounting on glass**  
 Endstütze für Glasmontage  
 Support borgne, fixation sur verre  
 Eindsteun voor montage op glas

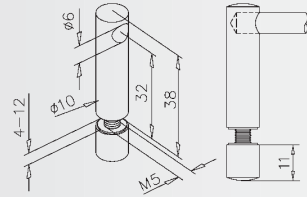

**Art.Nr.**

11.0680.006.20



11.0680.006.22



11.0680.006.23

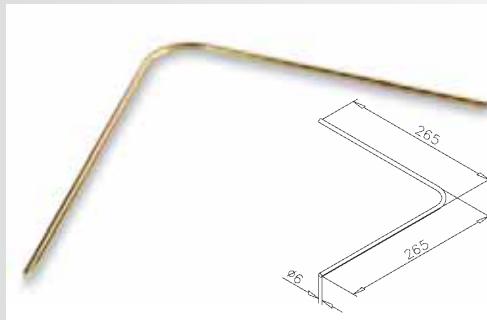

**„Mini rail“**  
**Rod 90°**  
 Stab 90°  
 Barre 90°  
 Staf 90°

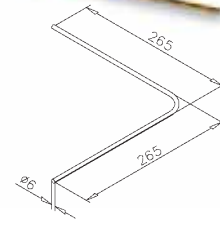

**Art.Nr.**

11.0940.006.20



11.0940.006.22



11.0940.006.23



**„Mini rail“**  
**Centre bracket for mounting on glass**  
 Mittelstütze für Glasmontage  
 Support traversant, fixation sur verre  
 Middensteun voor montage op glas

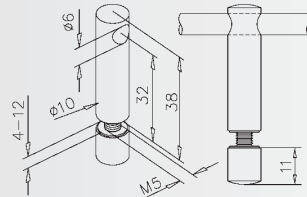

**Art.Nr.**

11.0681.006.20



11.0681.006.22



11.0681.006.23

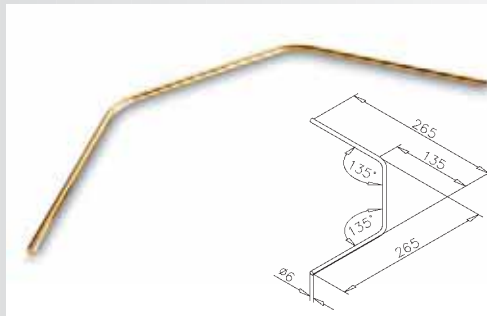

**„Mini rail“**  
**Rod 2 x 135°**  
 Stab 2 x 135°  
 Barre 2 x 135°  
 Staf 2 x 135°

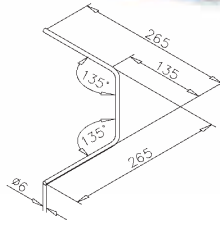

**Art.Nr.**

11.0941.006.20



11.0941.006.22



11.0941.006.23

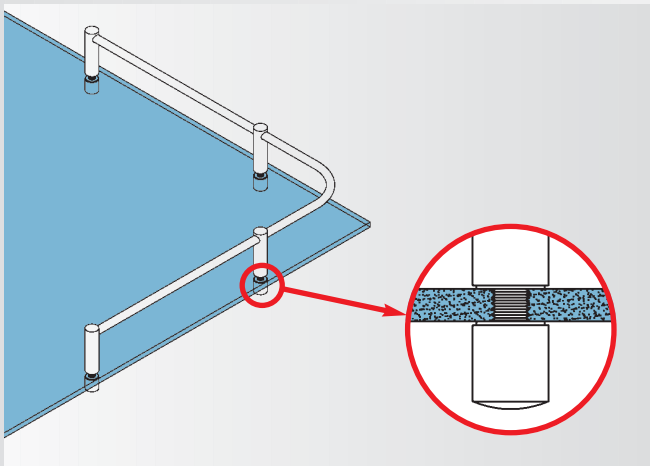

**Finishes / Oberflächen / Finitions / Afwerkingen**



**stainless steel effect**  
 Edelstahleffekt  
 aspect inox brossé  
 RVS look

**Art.Nr.** .....20



**brass effect polished**  
 Messingeffekt poliert  
 aspect laiton poli  
 Messing look gepolijst



**Art.Nr.** .....22



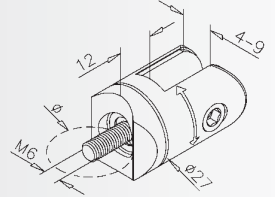
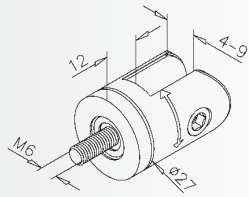

**chrome effect polished**  
 Chromeffekt poliert  
 aspect chromé brillant  
 Chrom look gepolijst



**Art.Nr.** .....23



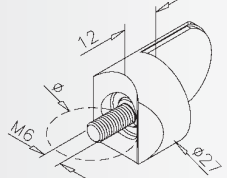
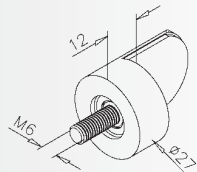

Art.Nr.
10.2900.000.20

10.2900.000.22

Art.Nr.	Ø
10.2900.025.20	25,4
10.2900.038.20	38,1
	
10.2900.025.22	25,4
10.2900.038.22	38,1
	

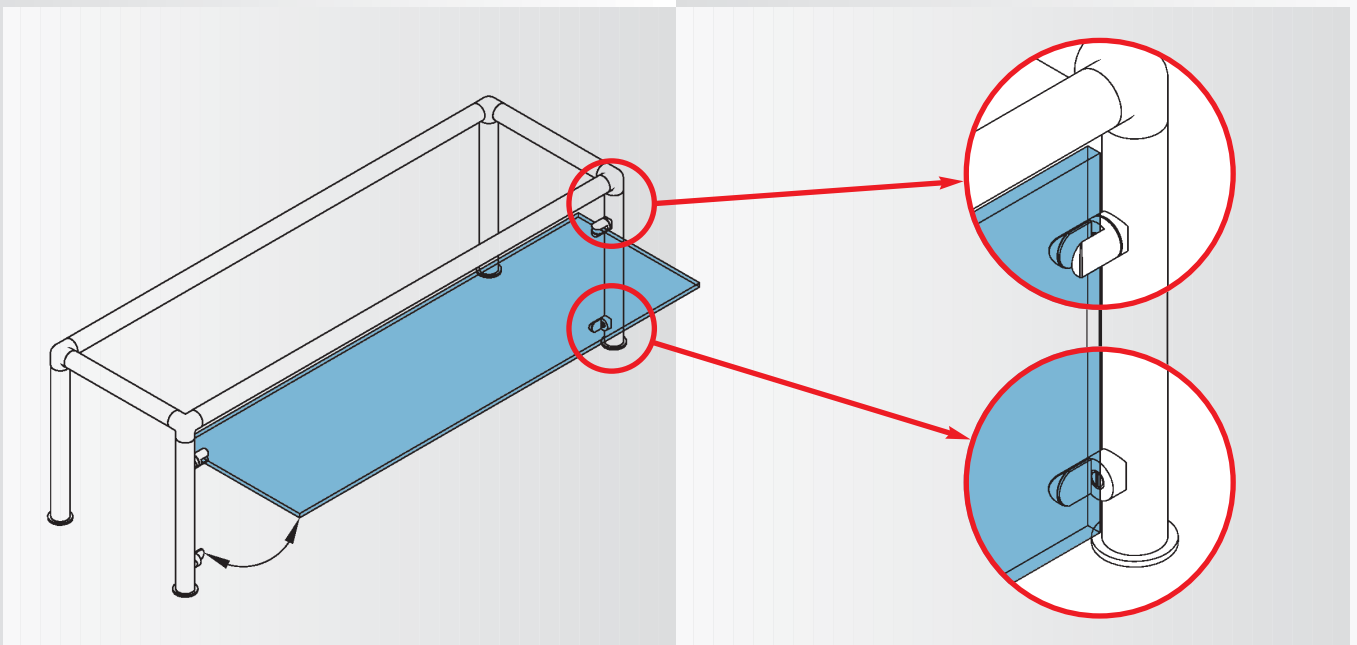

Art.Nr.
10.2950.000.20

10.2950.000.22

Art.Nr.	Ø
10.2950.025.20	25,4
10.2950.038.20	38,1
	
10.2950.025.22	25,4
10.2950.038.22	38,1
	



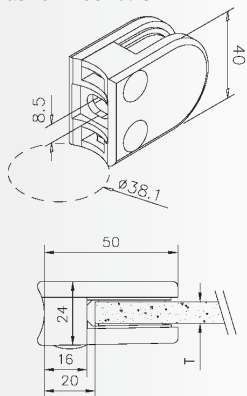

**Glass clamp for tube**  
 Glasklemme für Rohr  
 Pince à verre pour tube  
 Glasklem voor buis



Art.Nr.	T
10.2006.038.22	6 mm
10.2007.038.22	6,76 mm (3 - 0,76 - 3)
10.2008.038.22	8 mm



**Glass clamp for tube**  
 Glasklemme für Rohr  
 Pince à verre pour tube  
 Glasklem voor buis

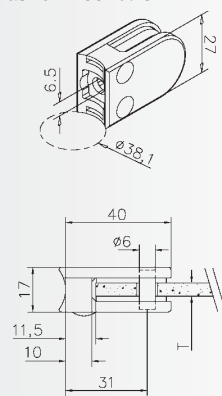

Art.Nr.	T
10.2706.038.22	6 mm
10.2707.038.22	6,38 mm (3 - 0,38 - 3)
10.2708.038.22	8 mm
10.2709.038.22	8,38 mm (4 - 0,38 - 4)



**Glass rack**  
 Gläserhalter  
 Support à verres  
 Glazenhouder

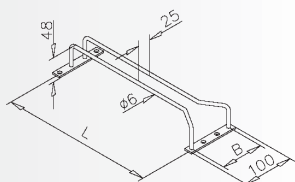

Art.Nr.	L	B
11.0873.300.22	300	84
11.0873.350.22	350	82
11.0873.400.22	400	82
11.0873.450.22	450	82
11.0873.300.23	300	84
11.0873.350.23	350	82
11.0873.400.23	400	82
11.0873.450.23	450	82



**Shelf support**  
 Glasplattenträger  
 Support tablette pour tube  
 Glasplankdrager

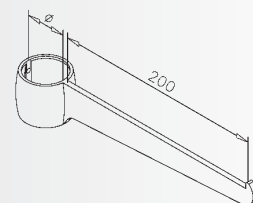

Art.Nr.	Ø
11.0741.025.22	25,4
11.0741.038.22	38,1
11.0741.025.23	25,4
11.0741.038.23	38,1





Rod  
Stab  
Barre  
Staf

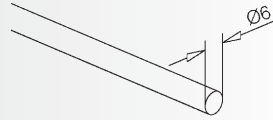

Art.Nr.	Ø	L
12.8925.006.12	6	2500 mm



11.8925.006.22	6	2500 mm
----------------	---	---------



11.8925.006.23	6	2500 mm
----------------	---	---------



cutted / zugeschnitten / coupé / gezaagd

Art.Nr.	Ø
12.8900.006.12	6



11.8900.006.22	6
----------------	---



11.8900.006.23	6
----------------	---



Rod  
Stab  
Barre  
Staf

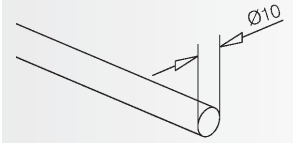

Art.Nr.	Ø	L
11.8925.010.22	10	2500 mm



11.8925.010.23	10	2500 mm
----------------	----	---------



cutted / zugeschnitten / coupé / gezaagd

Art.Nr.	Ø
11.8900.010.22	10



11.8900.010.23	10
----------------	----



### Finishes / Oberflächen / Finitions / Afwerkingen



satin stainless steel  
Edelstahl gebürstet  
inox brossé  
RVS geborsteld

Art.Nr. .... 12





Tube  
Rohr  
Tube  
Buis

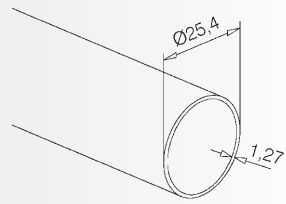

Art.Nr.	Ø	L
11.8925.025.22	25,4	2500 mm



11.8925.025.23	25,4	2500 mm
----------------	------	---------



**cutted** / zugeschnitten / coupé / gezaagd

Art.Nr.	Ø
11.8900.025.22	25,4



11.8900.025.23	25,4
----------------	------



Tube  
Rohr  
Tube  
Buis

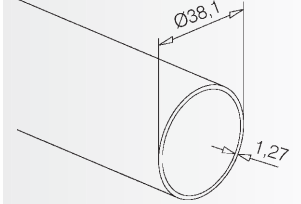

Art.Nr.	Ø	L
11.8925.038.22	38,1	2500 mm



11.8925.038.23	38,1	2500 mm
----------------	------	---------



**cutted** / zugeschnitten / coupé / gezaagd

Art.Nr.	Ø
11.8900.038.22	38,1



11.8900.038.23	38,1
----------------	------



Tube  
Rohr  
Tube  
Buis

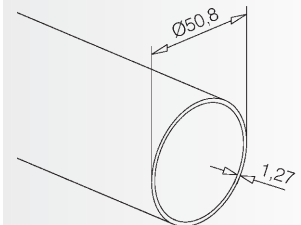

Art.Nr.	Ø	L
11.8925.050.22	50,8	2500 mm



11.8925.050.23	50,8	2500 mm
----------------	------	---------



**cutted** / zugeschnitten / coupé / gezaagd

Art.Nr.	Ø
11.8900.050.22	50,8



11.8900.050.23	50,8
----------------	------





Wall plate  
Wandauge  
Oeilleton mural  
Muuroog

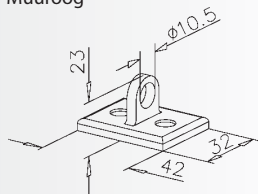

Art.Nr.  
11.5737.000.22



11.5737.000.23



Rope snap end  
Seilhalterhaken  
Mousqueton  
Koordhaak met verende pen

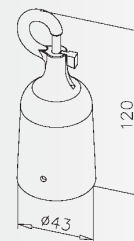

Art.Nr.  
11.5713.040.22



11.5713.040.23



Tube plate  
Rohrauge  
Oeilleton pour tube  
Buisoog

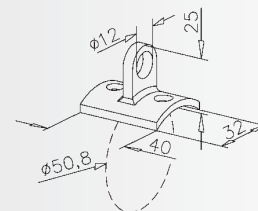

Art.Nr.  
11.5738.050.22



11.5738.050.23



Poly-hemp rope  
(incl. 2 rope snap ends)  
Hanfseil  
(inkl. 2 Seilhalterhaken)  
Cordon  
(avec 2 mousquetons)  
Hennep koord  
(incl. 2 koordhaken)  
L 1500 mm, Ø 40 mm



Velour rope  
(incl. 2 rope snap ends)  
Seil mit Samtüberzug  
(inkl. 2 Seilhalterhaken)  
Cordon velours  
(avec 2 mousquetons)  
Koord met velours  
(incl. 2 koordhaken)  
L 1500 mm, Ø 40 mm

Art.Nr.	Colour / Farbe / Couleur / Kleur
11.5850.040.22	nature / natur / naturel / natuur
11.5851.040.22	green / grün / vert / groen
11.5852.040.22	rosé / pastelrot / rouge / pastel rood
11.5853.040.22	bordeaux red / bordeaux / bordeau
11.5855.040.22	blue / blau / bleu / blauw
11.5850.040.23	nature / natur / naturel / natuur
11.5851.040.23	green / grün / vert / groen
11.5852.040.23	rosé / pastelrot / rouge / pastel rood
11.5853.040.23	bordeaux red / bordeaux / bordeau
11.5855.040.23	blue / blau / bleu / blauw

Art.Nr.	Colour / Farbe / Couleur / Kleur
11.5860.040.22	blue / blau / bleu / blauw
11.5861.040.22	green / grün / vert / groen
11.5862.040.22	red / rot / rouge / rood
11.5863.040.22	black / schwarz / noir / zwart
11.5860.040.23	blue / blau / bleu / blauw
11.5861.040.23	green / grün / vert / groen
11.5862.040.23	red / rot / rouge / rood
11.5863.040.23	black / schwarz / noir / zwart



**Guidance post**  
Absperstände  
Potelet tête sphérique  
Podiumstandaard

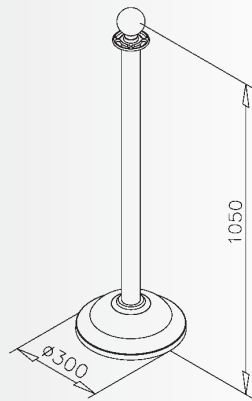



Weight 13 kg



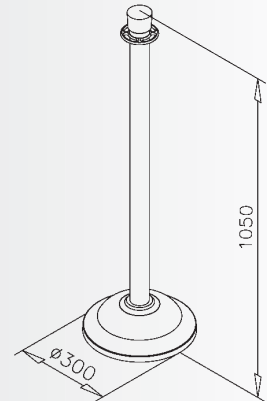

**Guidance post**  
Absperstände  
Potelet tête conique  
Podiumstandaard



Weight 13 kg

	Art.Nr. 11.5801.000.22
	11.5801.000.23

	Art.Nr. 11.5802.000.22
	11.5802.000.23



**Guidance post**  
Absperstände  
Potelet tête sphérique  
Podiumstandaard

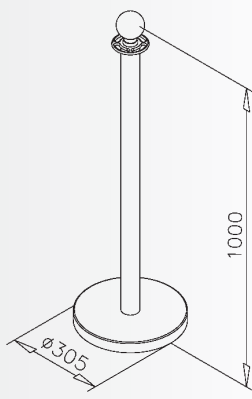



Weight 13 kg



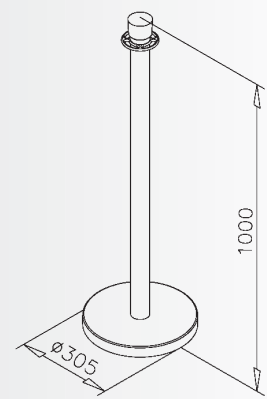

**Guidance post**  
Absperstände  
Potelet tête conique  
Podiumstandaard



Weight 13 kg

	Art.Nr. 11.5810.000.22
	11.5810.000.23

	Art.Nr. 11.5811.000.22
	11.5811.000.23